

Model 7001

Battery Operated Irrigation Controller with Hose or Pipe Thread

Features

- Weekly or cyclical programming
- 4 start times per day in weekly program
- Irrigation duration – from 1 minute to 11 hours and 59 minutes in 1 minute increments
- Irrigation frequency
 - Weekly program: 4 start times per day
 - Cyclical program: from 8 times per day (every 3 hours) to just once per month
- Simple, four-button programming
- Perform manual runs via the controller
- Powered by 1, 9-volt alkaline battery
- Low battery indicator
- Weather resistant



TABLE OF CONTENTS

INTRODUCTION	3
1. Parts identification	3
2. Setting up the irrigation controller	3
2.1 Assembly.....	3
2.2 Battery installation	4
2.3 Battery removal	4
3. Installation	4
3.1 In-line installation	4
3.2 Faucet installation	5
3.3 Manual mechanical operation	7
4. Irrigation programming	7
4.1 Programming method	7
4.2 Setting current time & day of the week	8
4.3 Programming a weekly irrigation schedule	8
4.4 Setting a cyclical irrigation program	10
4.5 Manual run	12
4.6 Suspend irrigation (Rain Off)	13
5. Additional displays	13
5.1 Blinking low battery warning	13
5.2 Missing definition in irrigation program	13
5.3 Programming error	14
6. Helpful hints and additional information	14
7. Maintenance and specifications	14
8. Troubleshooting & repairs	15
To order replacement or spare parts	16

INTRODUCTION

Thank you for purchasing DIG's 7001 irrigation controller.

Please take the time to read through the enclosed instructions and follow them step by step. If you have any questions, please call our customer service line 1-800-344-2281.

1. PARTS IDENTIFICATION

- 1) Top cover
- 2) Controller display
- 3) Mechanical operating handle
- 4) Programming & operating buttons
- 5) Water flow direction
- 6) Skirt
- 7) Hydraulic valve

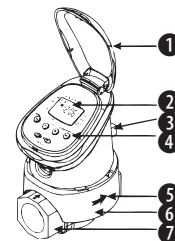

2. SETTING UP THE IRRIGATION CONTROLLER

2.1 ASSEMBLY

The 7001 controller has a 3/4" inlet and outlet with female pipe thread so it can be installed directly onto 3/4" PVC male pipe thread fittings as part of a sprinkler valve manifold or as a stand-alone unit. (Fig. 1)

OR

The 7001 controller can be attached to a hose or faucet/spigot using the two adapters that are included with the controller. (Figure 2)



Figure 1

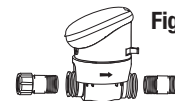

Figure 2

Warning: Wrap all fittings with Teflon tape! Do not use pipe cement on valve! This will damage the valve and void the warranty!

NOTE: The correct installation of the controller is where the orange handle is away from the faucet and the controller's digital display reading is facing the faucet. Make sure that the flow direction arrow engraved on the side of the controller is pointed away from the water source.

2.2 BATTERY INSTALLATION

1. Holding the upper section of the controller above the mechanical handle, use a firm upward twist to release the controller from the skirt.
2. Invert the controller and use firm pressure to lift the battery compartment cover (1).
3. Check polarity then insert the lower end of the 9-volt alkaline battery (2) first. Then press on the top end (3) to lock down the battery in place.

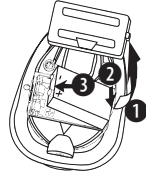
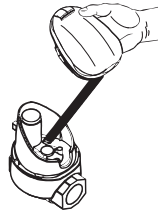

2.3 BATTERY REMOVAL

1. Remove the battery compartment cover (4).
2. Lift the lower end of the battery (5) first. If necessary, use the flat end of a small screwdriver.

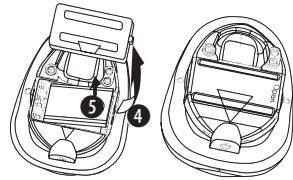

- **Removing the batteries from the top end may damage the connections.**

- **Use alkaline batteries only.**

NOTE: Battery polarity is marked in the battery compartment.

3. Replace battery compartment cover in its proper place, ensuring a triangle is formed on the underside of the controller.

3. INSTALLATION

Recommended Working Pressure: 10-80 PSI

3.1 IN-LINE INSTALLATION

1. Shut off main water supply.
2. Install a 3/4" ball or gate valve onto the PVC pipe or to the valve manifold before installing the controller (Figure 3a).

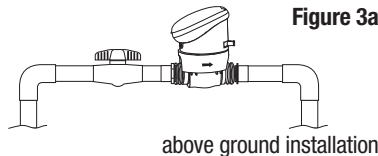

Figure 3a

3. Turn water supply on to flush the line and then shut the water off using the ball or gate valve.
4. Install the controller wrapping Teflon tape on all male thread fittings.
5. Turn water supply on to pressurize the system. The controller will open momentarily and then will shut off.
6. Program the controller (Section 4 – Irrigation Programming).

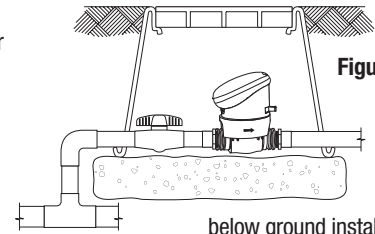

Figure 3b

3.2 FAUCET INSTALLATION

1. First attach the swivel female hose thread (FHT) by male pipe thread (MNPT) adapter to the inlet side of the controller. Do this by threading the male side of the adapter to the controller inlet, see arrow for water flow direction (Figure 4a) Make sure to wrap MNPT with teflon tape.
2. Attach the male hose thread by male pipe thread adapter to the outlet side of the controller (Figure 4b).
3. Connect the controller to the faucet using the swivel adapter (Figure 5a).

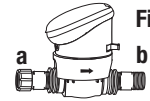

Figure 4

Basic installation.

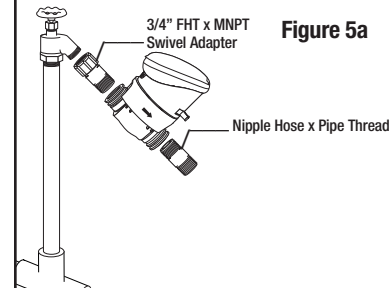

Figure 5a

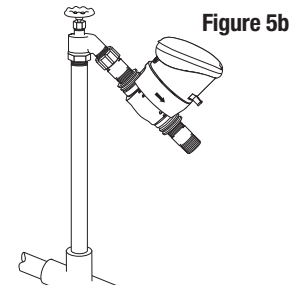
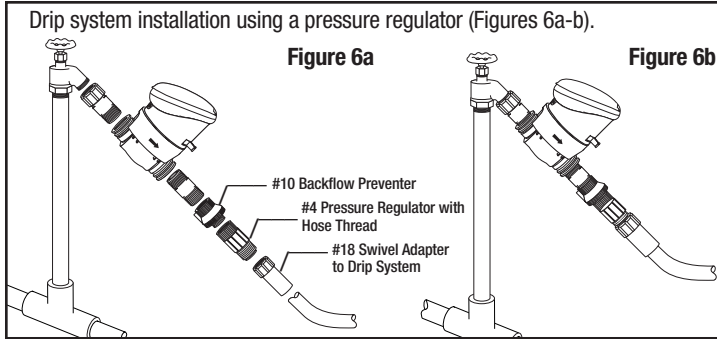
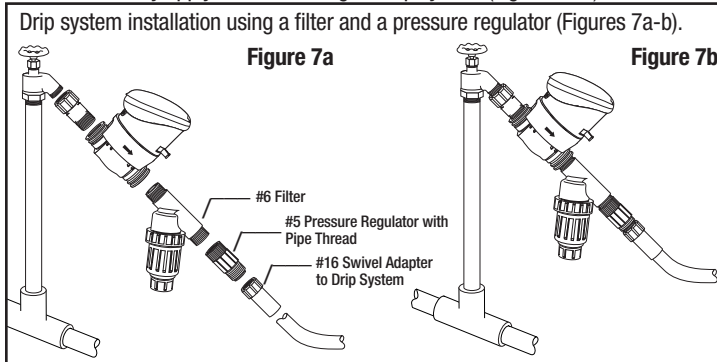

Figure 5b

If a backflow preventer is part of the faucet (new houses) do not install any other backflow preventer to the faucet. If backflow preventers are part of your city code and you have purchased a unit as part of your drip system, install the device on the downstream side of the 7001 (Figure 6a-b).



It is best to include a filter on a drip system. The filter cleans small particles out of the water that would otherwise clog the small orifices of the drippers. Filters can also automatically apply fertilizer through a drip system (Figure 7a-b).



4. Turn the faucet on, the controller will open momentarily and then will shut off.
5. Program the controller. (Section 4 – Irrigation Programming)

3.3 MANUAL MECHANICAL OPERATION

The irrigation valve can be opened and closed independent of controller operation. Manual operation is useful when irrigation is required immediately but there is inadequate time and/or knowledge for programming or the battery is unavailable. The manual operating handle is located in the front, lower section of the skirt. It has two settings: open (1) and automatic (2).

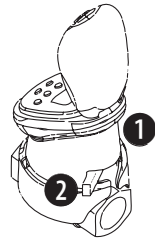





NOTE: The manual operating handle can only open the valve, it cannot close the valve if the irrigation controller program opened it.

REMEMBER: The manual operating handle must be on automatic (AUTO) for controller operated irrigation.

4. IRRIGATION PROGRAMMING

4.1 PROGRAMMING METHOD

-  Programming step – used to select the appropriate programming mode (e.g.) clock setting mode.
-  Data decrement (decrease) – lowers the value of the selected parameter (e.g. deducts an hour).
-  Data increment (increase) – raises the value of the selected parameter (e.g. adds on an hour).
-  Flash button – used to select the parameter to be changed (e.g. hour, minute, etc.) To implement the change, the selected parameter must be flashing.





If no changes are implemented, the controller display will always revert to the main screen (clock).

NOTE: If the controller is not programmed the clock will flash continuously. After 10 minutes the controller will implement 5-minute irrigation duration on a 24-hour cycle (default mode).



4.2 SETTING CURRENT TIME & DAY OF THE WEEK







To enable the irrigation controller to operate the irrigation system at the required times, the current time and day of the week must be set as shown below:

Setting the Clock:

1. After installing battery  appears.
2. Press  and the hour digits flash. Set the current hour with the aid of  and .

(Note: AM and PM designations appear.)

To change the display between the American and European clocks, press concurrently on  and  buttons. The hour digits can not be flashing for this to work.

3. Press  and the minute digits flash. Set the current minute with the aid of  and .
4. Press  and a flashing drop will appear at the top of the display. Set the flashing drop on the current day of the week by pressing  and .

NOTE: Display digits will stop flashing after 10 seconds. If the last parameter stops flashing before programming is complete press  to continue the process.

4.3 PROGRAMMING A WEEKLY IRRIGATION SCHEDULE (Specific days of the week)

There are two options for setting irrigation frequency:



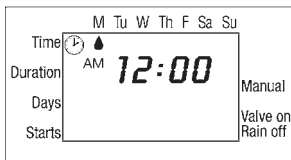

Cyclical Mode (see 4.4), where watering occurs at a pre-set interval (one start time per day in this mode). Weekly Schedule Mode (see 4.3) where watering occurs on specific days of the week (up to four start times per day in this mode). You must select one mode or the other, not both.

NOTE: After programming the controller, test the controller via the manual button (see section 4.5).









This section illustrates an example of weekly irrigation programming. Alter the data in the example to meet the requirements of the project being installed. Let's assume that we want to program the irrigation controller to water three times a day (8:30 am, 1 pm and 7 pm) for 10 minutes each time, on Tuesdays and Fridays.

Programming Duration of Irrigation

1. Press  until  appears opposite "Duration".
2. First the hour digit is flashing (0). We do not want to irrigate for hours, so skip to next step.
3. Press  and the minute digits will flash. Press  or  until the minute digits reach 10.







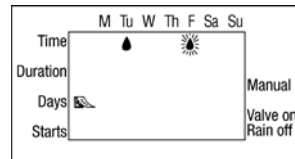

Programming Irrigation Days

1. Press  and the  will appear opposite the word "Days". If programming the controller for the first time, the word OFF will flash on the display.
2. Press  and a flashing drop will appear under Monday in the upper section of the display. Using  to position the flashing marker under Tuesday. Press  and the marker under Tuesday will stop flashing, become solid, and a new flashing drop will move to the right positioning itself under Wednesday. Press  twice more until the flashing marker reaches Friday. Press  again to select. Droplets will be present and not flashing on the days selected to irrigate.



Setting Irrigation Start Time/Date:

1. Press  and the words START I appear and 12:00 am will be flashing on the display.
2. Use  or  set the start time at 8 AM (note the AM and PM indicators). Press  to move to the minute digits and use  or  to set to 30 minutes. Press  and repeat this operation for the second irrigation period (START II) at 1:00 PM, and for the third irrigation period (START III) at 7:00 PM.



- To cancel one of the start times, select the start time by pressing **▶** until the desired start time is reached. The hour digit flashes automatically. Press **⊕** or **⊖** until the word OFF appears, which is between 11:00 PM and 12:00 AM. Press **▶** to move to the next mode.

4.4 SETTING A CYCLICAL IRRIGATION PROGRAM



This section illustrates an example of cyclical irrigation programming. Alter the data in the example to meet the requirements of the project being installed. Let's assume that we want to program the irrigation controller to open the valve at 10:45 am for a duration of 1.5 hours, once every three days, starting on Monday.

Setting Irrigation Duration

- Press **▶** until  appears near "Duration".
- Press **↔** and the hour digits flash. Press **⊕** or **⊖** until the hour digit changes to 1. Press **↔** until the minute digits flash. Press **⊕** or **⊖** until the minute digits changes to 30.



Setting Irrigation Cycle

- Press **▶** until  appears.
- Press **↔** a number of times (go through all the days of the week) until the word OFF flashes on the display.
- Press **▶** as long as the display is flashing.  will appear on the display and the word OFF will flash.
- Press **⊕** until the word DAYS appears on the display and the digit 3 is flashing.

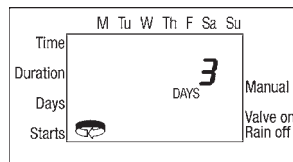
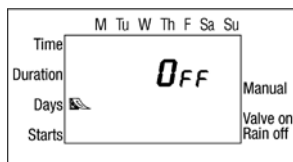

Setting Irrigation Start Time and Start Day:

- Press **▶** and START will appear and the start time will flash.
- Press **⊕** or **⊖** until the hour displayed reads 10 AM.
- Press **↔** once and the minute display will flash.
- Press **⊕** or **⊖** until the minutes displayed reach 45.
- Press **↔** once. The marker under Monday will flash. That will be your starting day.

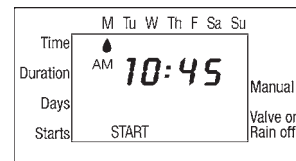

NOTE: In a cyclical program, the irrigation days will vary from week to week because of cycle length.

NOTE: To get out of cyclical mode, press **▶** button until  appears next to "Starts". Press **⊖** button until "OFF" appears on the display. Press **▶** button again to return to current time screen.

Example:

If the cyclical irrigation program in section 4.4 begins on Monday and operates every 3 days:

This would be the order of the cycle in two weeks.

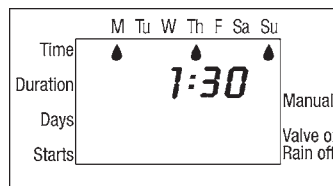

Week 1

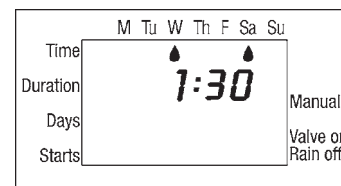

Week 2

But if the program starts on Tuesday:

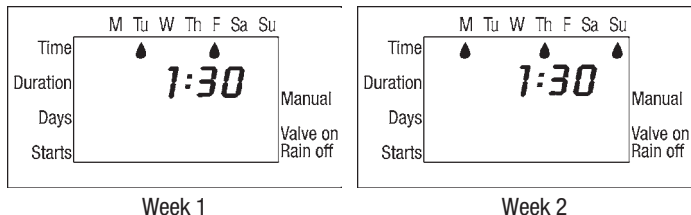

4.5 MANUAL RUN

Manual run temporarily turns on the system. The valve will close automatically at the end of the irrigation period.

NOTE: The originally programmed irrigation schedule will continue to function at the set times. This setting cannot be implemented when the display is flashing.

Manual Operation Via the Controller:

Press until current time is displayed. Press

and the will appear next to the word

“Manual”. The symbol will appear underneath

it and the valve will open.

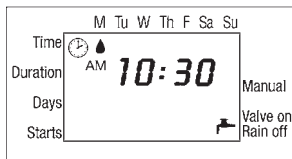

The days of the week and the irrigation duration that was set in the program will appear on the display.

Canceling Operation:

Press again and the and symbols will disappear from the display.

NOTE: If the irrigation duration is set at zero (0:00) in automatic mode, irrigation will not occur and *noPr* will appear on the display.

4.6 SUSPEND IRRIGATION (Rain Off)

This option is used to temporarily suspend irrigation controller operation, for example, while it is raining. Programmed schedules remain in the controller memory but are not implemented until the suspension is cancelled.

Suspension:

Press and hold down for 5 consecutive seconds until the appears.

Cancel Suspension:

Press and hold down for 5 consecutive seconds to restart the scheduled programs in the controller. The symbol will disappear.

NOTE: During suspension the button will not function.

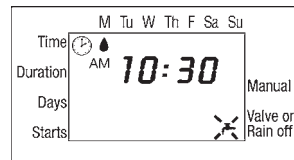

5. ADDITIONAL DISPLAYS

5.1 BLINKING LOW BATTERY WARNING

A flashing battery icon appears on the display when the batteries are weak. At this point, the battery still contains a limited amount of energy for valve operation. The battery should be replaced promptly.

If the battery is not replaced, the irrigation controller will continue to open the valve 8 additional times according to the program. It will then suspend the program and OFF will appear on the screen.

Program data will be retained for 30 seconds during battery changing.

An irrigation controller without a battery will not operate the valve.



5.2 MISSING DEFINITION IN IRRIGATION PROGRAM

noPr will appear if irrigation days have not been specified after programming (see Section 4).

In this case, the valve cannot be opened for manual operation.

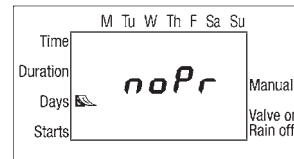

5.3 PROGRAMMING ERROR

In the cyclical program (see section 9) if the irrigation duration programmed is equal to or longer than the irrigation cycle, the word *Err* will appear.

To cancel the error, press ⊕ or ⊖ to increase the irrigation cycle.

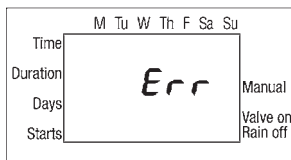

6. HELPFUL HINTS AND ADDITIONAL INFORMATION

1. A manual run can be started at any time when current time is displayed by pressing the manual button once. The valve will operate one time for the length of time programmed and then proceed back to the normal programming.
2. All DIG controllers can be programmed in the comfort of your home or office and installed at a later date. No water pressure is required.
3. Always make sure that the battery compartment is clean and dry. If water should get on the battery, immediately remove and wipe clean.
4. We strongly recommend brand name alkaline batteries. Rechargeable batteries are not recommended.
5. Under normal usage, batteries (alkaline) will last for a minimum of 1 year, maximum of 2 years.
6. It is good operating practice to replace old batteries with new ones at the start of the irrigation season.

7. MAINTENANCE AND SPECIFICATIONS

- Recommended operating water pressure range: 10-80 PSI
- Operating water pressure range: 10-125 PSI
- Flow rates: .5-28 GPM

If the controller is not going to be in use for an extended period of time, remove batteries and replace cover securely. After an extended period without batteries the controller will need to be reprogrammed. During battery replacement programming will be retained for up to 30 seconds.

KEEP BATTERY COMPARTMENT SECURELY CLOSED AT ALL TIMES.

Remove controller and store indoors when temperature drops below 32° for a prolonged period of time.

Be sure to shut off water supply before removal.

8. TROUBLESHOOTING AND REPAIRS

PROBLEM: Valve does not open during automatic operation or during “manual” operation via irrigation controller.

CAUSE: Debris blocking ports below solenoid.

SOLUTION: Unscrew solenoid and adapter and clear all outlet ports. (see illustration below)

CAUSE: Faucet is turned off.

SOLUTION: Turn on the faucet.

CAUSE: Solenoid or solenoid wire is faulty.

SOLUTION: Replace solenoid and controller.

PROBLEM: No display.

CAUSE: Weak batteries.

SOLUTION: Replace batteries.

PROBLEM: Valve does not close despite clicks heard during activation.

CAUSE: Outlet flow may be too low (minimum flow .5 GPM).

SOLUTION: Increased flow rate by adding drip emitters or micro sprinklers.

CAUSE: Valve is installed backwards.

SOLUTION: Reverse valve.

CAUSE: Hole in diaphragm is clogged or diaphragm is torn.

SOLUTION: Clean or replace diaphragm.

CAUSE: Orange handle is in open position.

SOLUTION: Move handle to auto position (section 3.3).

PROBLEM: Valve does not fully close.

CAUSE: Debris stuck in diaphragm.

SOLUTION: Remove cover and diaphragm and rinse thoroughly under running water.

**TO ORDER REPLACEMENT OR SPARE PARTS:
PLEASE ORDER ONLINE AT WWW.DIGCORP.COM**

We at DIG Corporation understand that most dealers do not carry spare parts. For your convenience, if you need one of these parts, please order online at www.digcorp.com.

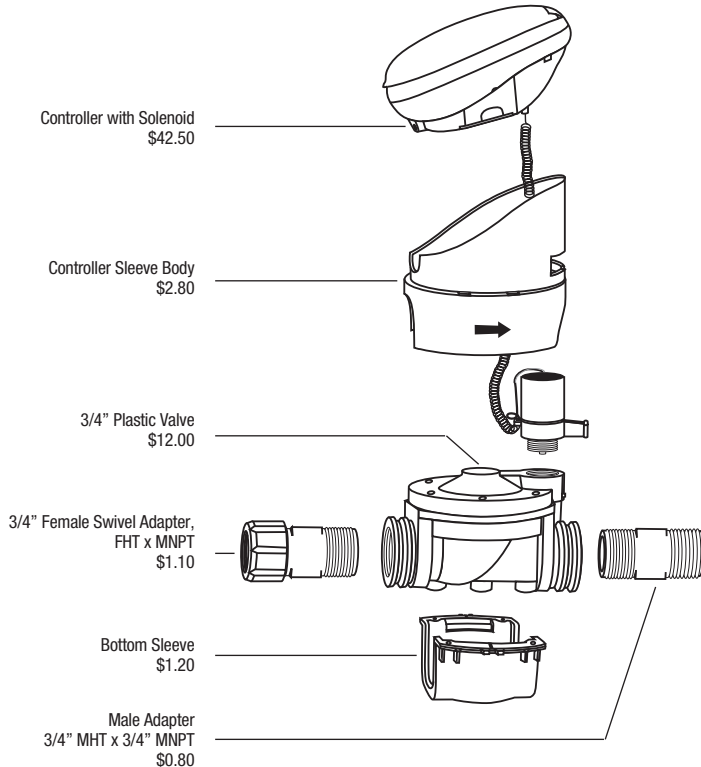

*Prices subject to change without notice.

WARRANTY

DIG CORPORATION warrants these products to be free from defects in material and workmanship for a period of three years from date of purchase. This warranty does not cover damage resulting from accident, misuse, neglect, modification or improper installation. This warranty shall extend only to the original purchaser of the product for use by the purchaser. This warranty shall not cover batteries or any malfunction of the product due to battery failure. The obligation of DIG CORPORATION under this warranty is limited to repairing or replacing at its factory this product which shall be returned to the factory within three years after the original purchase and which on examination is found to contain defects in material and workmanship.

DIG CORPORATION SHALL IN NO EVENT BE LIABLE FOR ANY INCIDENTAL OR CONSEQUENTIAL DAMAGES OF ANY KIND; THE SOLE OBLIGATION OF DIG BEING LIMITED TO REPAIR OR REPLACEMENT OF DEFECTIVE PRODUCTS. SOME STATES DO NOT ALLOW THE EXCLUSION OR LIMITATION OF INCIDENTAL OR CONSEQUENTIAL DAMAGES, SO THE ABOVE LIMITATION OR EXCLUSION MAY NOT APPLY TO YOU.

Unattended use for prolonged periods without inspection to verify proper operation is beyond the intended use of this product, and any damage resulting from such use shall not be the responsibility of DIG CORPORATION. There are no warranties which extend beyond the description on the face hereof. In the case of purchase of the product for use other than, for irrigation purposes, DIG CORPORATION hereby disclaims any implied warranties including any warranties of merchantability and fitness for a particular purpose. In the case of the purchase of the product for personal, family or household purposes, DIG CORPORATION disclaims any such warranties to the extent permitted by law. To the extent that any such disclaimer or implied warranties shall be ineffectual, then any implied warranties shall be limited in duration to a period of three years from the date of the original purchase for use by the purchaser. Some states do not allow limitation on how long an implied warranty lasts, so the above limitation may not apply to you.

In order to obtain performance under this warranty, the unit must be returned to the factory, along with proof of purchase indicating original date of purchase, shipping prepaid, addressed as follows:

DIG CORPORATION, 1210 Activity Drive, Vista, CA 92081-8510. Repaired or replaced units will be shipped prepaid to the name and address supplied with the unit returned under warranty. Allow four weeks for repairs and shipping time. Repair of damaged units not otherwise within warranty may be refused or done at a reasonable cost or charge at the option of DIG CORPORATION.

This warranty gives you specific legal rights, and you may also have other rights which vary from state to state.

TECHNICAL ASSISTANCE

Should you encounter any problem(s) with this product or if you do not understand its many features, please refer to this instruction manual first. If further assistance is required, DIG offers the following customer support:

TECHNICAL SERVICE USA

- **DIG's Technical Service Team** is available to answer questions in English and Spanish from 8:00 AM to 5:00 PM (PST) Monday-Friday (except holidays) at 800-344-2281.
- **Questions** in English and Spanish can be e-mailed to questions@digcorp.com or faxed to 760-727-0282.
- Specification documents and manuals are available for downloading in English and Spanish at www.digcorp.com.



1210 Activity Drive
Vista, CA 92081-8510, USA

Website:

www.digcorp.com

e-mail: dig@digcorp.com

062111 DIG CORP 26-020

Printed in the USA

DIG is a Registered Service Mark of DIG Corp.

